



深圳市宇锡科技有限公司

SHENZHEN YOUSEE TECHNOLOG CO., LTD

DISPLAY SPECIFICATION

Product NO: (产品型号) YX140FHM-N10

Customer : (客 户) _____

APPROVED BY CUSTOMER 客户签署栏	
Approved by 审核	Remark 备注

APPROVED BY YOUSEE 宇锡签署栏			
Prepared by 制作	Checked by 检查		Approved by 审核
	电子	结构	

深圳市宇锡科技有限公司 Shenzhen Yousee Technology Co.,Ltd 邹长城 LONG Tel:15818552076 E-mail: zouchangcheng@youseelcd.com Adress:深圳市西乡簕竹角鸿竹雍启 C 栋 5 楼, D 栋 2 楼 2F bldg D and 5F, bldg C, Hongzhu Yongqi, Lezhujiao, Xixiang, Shenzhen



REVISION HISTORY

REV.	ECN No.	DESCRIPTION OF CHANGES	DATE	PREPARED
P0		Initial Release	2021.10.28	



Contents

No.	Items	Page
1.0	General Description	P4
2.0	Absolute Maximum Ratings	P6
3.0	Electrical Specifications.	P7
4.0	Optical Specifications.	P11
5.0	Data Gate IC Pad & FPC Assignment	P13
6.0	Mechanical Characteristics	P17
7.0	Appendix	P21
8.0	Reliability Test	P23
9.0	Handling & Cautions	P24
10.0	Packing	P27



1.0 GENERAL DESCRIPTION

1.1 Introduction

B6 YX140FHM-N10 is a color active matrix LTPS LCD using Low Temperature Poly-sil icon TFT' s (Thin Film Transistors) as an active switching devices. The LTPS-LCD has a 13.92 inch diagonally measured active area with FHD resolutions (1920horizontal by 1080vertical pixel arrays). Each pixel is divided into RED, GREEN, BLUE dots which are arranged in vertical stripe and this module can display 16.7M colors.

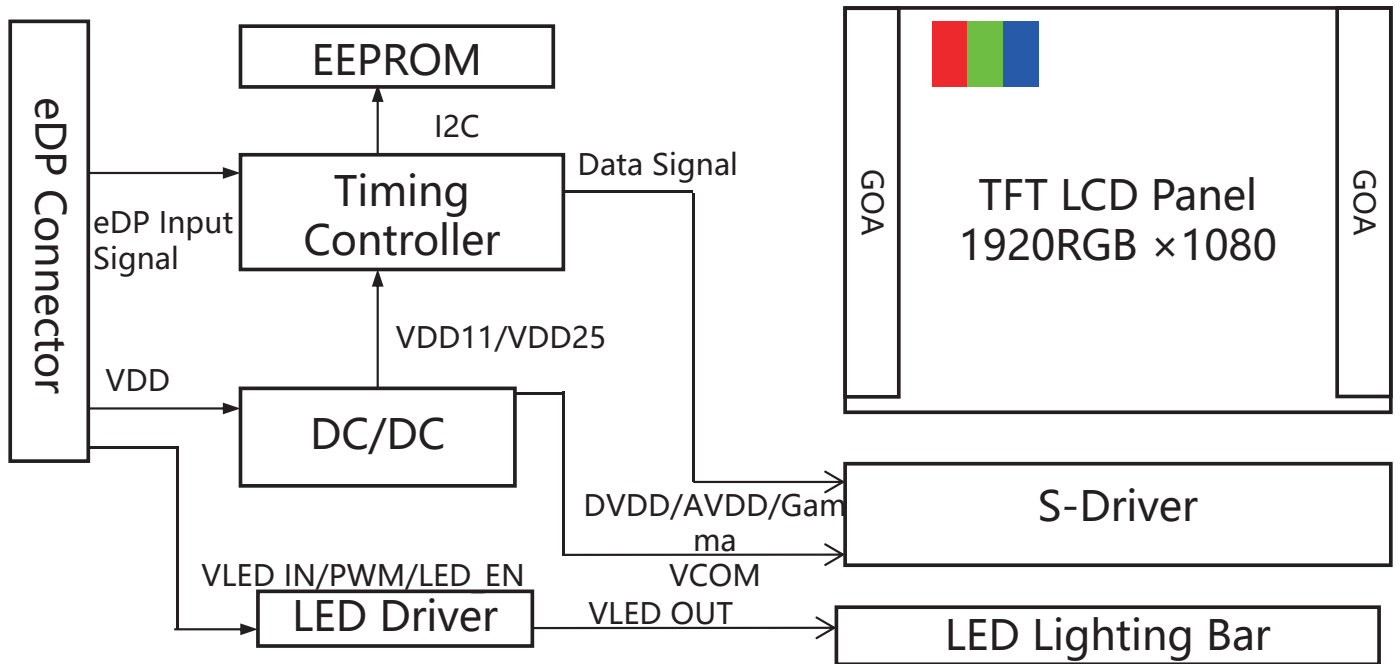

1.2 Features

- Border (L/R/U/D) : 2.0/2.0/2.0/5.5
- NTSC : 73%
- wide viewing angle (U/D/L/R) : 80/80/80/80



1.3 Application

- POS terminals machine

1.4 General Specification

The followings are general specifications of **YX140FHM-N10**.

<Table 1. General Specifications>

Parameter	Specification	Unit	Remarks
Active area	308.16(H) x 173.34(V)	mm	
CF size	312.16(H) x 177.34(V)	mm	
Number of pixels	1920(H) × 1080(V)	pixels	FHD
Pixel pitch	53.5 x 160.5	μm	
Pixel arrangement	RGB Vertical stripe		
Display colors	16.7M	colors	
Color gamut	Typ. 73, Min 65	%	
Display mode	Normally black		
Panel Size	317.16(H) x 186.54(V)	mm	
IC	TC2055G		
Power Consumption	436(TYP.)	mW	DP803,White
	470(TYP.)	mW	DP689,White



2.0 ABSOLUTE MAXIMUM RATINGS

The followings are maximum values which, if exceed, may cause faulty operation or damage to the unit. The operational and non-operational maximum voltage and current values are listed in Table 2.

< Table 2. Absolute Maximum Ratings >

Parameter	Symbol	Min.	Typ .	Max.	Unit	Remarks
Power Supply Voltage	V_{DDIN}	3	3.3	5.0	V	Ta = 25 °C Note 1&2
eDP input Voltage	DP803:VeDP	-0.3	2.5	2.88	V	
	DP689:VeDP	-0.5	2.5	3.6	V	
LC operating Voltage [1]	V_{OP}	4.9	5.3	-	V	Ta=25+/-2°C
Operating Temperature (Humidity)	T_{OP}	-20	25	+70	°C	At 60°C
	RH	10	-	90	%	
Storage Temperature (Humidity)	T_{ST}	-30	25	+80	°C	At 60°C
	RH	10	-	90	%	

[1] Liquid Crystal driving voltage

Due to the characteristics of LC Material, this voltage varies with environmental temperature.

Note:

1. These range above is maximum value not the actual operating value . Actual Operating temperature is 25°C .
2. BOE is not responsible for product problems beyond the use conditions.
3. Temperature and relative humidity range are shown in the figure below. Wet bulb temperature should be 39 °C max. and no condensation of water.

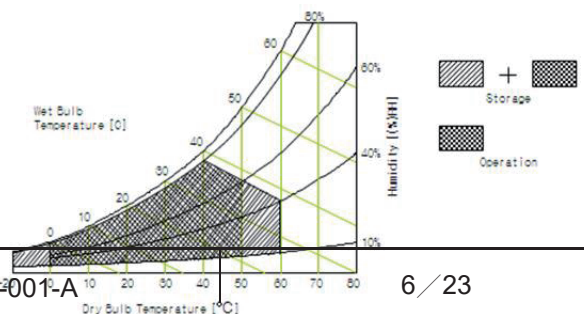



3.0 ELECTRICAL SPECIFICATIONS

3.1 Electrical Specifications

< Table 3. Electrical specifications >

[Ta =25±2 °C]

Parameter	Symbol	Value	Unit	Remarks
TFT Gate ON Voltage	VGH	8	V	7.5~8.5
TFT Gate OFF Voltage	VGL	-8	V	-7.5~-8.5
TFT Common Electrode Voltage	VCOM	-0.2	V	
I/O Supply Voltage	IOVCC	1.8	V	具体IC需求
Liquid crystal driver supply voltage	VSP	5.5	V	具体IC需求
Liquid crystal driver supply voltage	VSN	-5.5	V	具体IC需求
Frame Frequency	f_Frame	60	Hz	

Notes :

1. VGH is TFT Gate operating voltage.
2. VGL is TFT Gate operating voltage. The low voltage level of VGL signal must be fluctuates with same phase as Vcom.
3. Vcom must be adjusted to optimize display quality, as Crosstalk and Contrast Ratio etc..
4. The value is just the reference value. The customer can optimize the setting value .



3.0 ELECTRICAL SPECIFICATIONS

3.2 TFT LCD Module

< Table 4. LCD Module Electrical specifications >

Parameter		Min.	Typ.	Max.	Unit	Remarks
Power Supply Voltage	V_{DDIN}	2.6	3.3	5.0	V	
Power Supply Current	I_{DDIN}	-	135	200	mA	TCON:DP803
		-	145	210	mA	TCON:DP689
LED Driver Supply Voltage	V_{LEDIN}	11	12	13	V	
LED Driver EN	LED_ENIN	2	3.3	5	V	
PWM	frequency	180	-	20000	Hz	
	duty	0	-	100	%	
	High level I	2.3	2.5	2.7	V	
Power Consumption	P_D	-	436	550	mW	DP803 White Pattern
		-	448	580	mW	DP803 R/G/B Pattern
		-	470	600	mW	DP689 White Pattern
		-	485	630	mW	DP689 R/G/B Pattern

Notes :

1. The supply voltage is measured and specified at the interface connector of FOB.
2. The current draw and power consumption specified is for $V_{DDIN}=3.3V$, Frame rate=60Hz. Test Pattern of power supply current is White pattern.



3.3 INPUT TERMINAL PIN ASSIGNMENT

The electronics interface connector is W05030-30P-H/IS050-L30B-C10
The connector interface pin assignments are listed in Table 5.

<Table 5. Pin Assignments for the Interface Connector>

Terminal	Symbol	Functions
Pin No.	Symbol	Description
1	CABC_ENIN	Disable
2	GND	Ground
3	DRX1N	eDP RX Channel 1 Negative
4	DRX1P	eDP RX Channel 1 Positive
5	GND	Ground
6	DRX0N	eDP RX Channel 0 Negative
7	DRX0P	eDP RX Channel 0 Positive
8	GND	Ground
9	DAUXP	eDP AUX CH Positive
10	DAUXN	eDP AUX CH Negative
11	GND	Ground
12	VDDIN	Power Supply, 3.3V (typ.)
13	VDDIN	Power Supply, 3.3V (typ.)
14	BIST	No Connection
15	GND	Ground
16	GND	Ground
17	HPD	Hot Plug Detect Output
18	GND	Ground
19	GND	Ground
20	GND	Ground
21	GND	Ground
22	LED_ENIN	LED Enable Pin(+3.3V Input)
23	PWM	System PWM Signal Input
24	NC	No Connection
25	NC	No Connection
26	VLEDIN	LED Power Supply 12V
27	VLEDIN	LED Power Supply 12V
28	VLEDIN	LED Power Supply 12V
29	VLEDIN	LED Power Supply 12V
30	NC	No Connection



3.4 Pin assignment for LED Bar

-LED connector: MSK24022P10D/FC0510-L0822W560H100-N01

< Table6. Pin assignment for LED Bar >

Pin No	Symbol	Description
1	LED1	LED cathode connection
2	LED2	LED cathode connection
3	LED3	LED cathode connection
4	LED4	LED cathode connection
5	NC	No Connection
6	NC	No Connection
7	NC	No Connection
8	VLEDOUT	LED anode connection
9	VLEDOUT	LED anode connection
10	VLEDOUT	LED anode connection



4.0 OPTICAL SPECIFICATION

4.1 Overview

The test of Optical specifications shall be measured in a dark room (ambient luminance ≤ 1 lux and temperature = $25 \pm 2^\circ\text{C}$) with the equipment of Luminance meter system (Goniometer system and TOPCON BM-5) and test unit shall be located at an approximate distance 50cm from the LCD surface at a viewing angle of θ and Φ equal to 0° . We refer to $\theta\emptyset=0$ ($=\theta_3$) as the 3 o'clock direction (the "right"), $\theta\emptyset=90$ ($=\theta_{12}$) as the 12 o'clock direction ("upward"), $\theta\emptyset=180$ ($=\theta_9$) as the 9 o'clock direction ("left") and $\theta\emptyset=270$ ($=\theta_6$) as the 6 o'clock direction ("bottom"). While scanning θ and/or \emptyset , the center of the measuring spot on the Display surface shall stay fixed.

Optimum viewing angle direction is 6 "clock.

4.2 Optical Specifications

Item	Symbol	Condition	Min	Typ.	Max	Unit	Note
Transmittance	Tr	Perpendicular	3.6	4.2	-	%	Note.3
Viewing Angle	θ_L	CR \geq 10	70	80	-	°	Note.1
	θ_R		70	80	-		
	ψ_T		70	80	-		
	ψ_B		70	80	-		
Contrast Ratio	Cr	Perpendicular	800	1200	-	-	Note.2
Response Time	Tr.+Tf.		-	30	-	ms	Note.5
Color Coordinate of CIE1931	Rx	Perpendicular	0.612	0.642	0.672	-	Note. 4
	Ry		0.312	0.342	0.372		
	Gx		0.285	0.315	0.345		
	Gy		0.578	0.608	0.638		
	Bx		0.121	0.151	0.181		
	By		0.017	0.047	0.077		
	Wx		0.271	0.301	0.331		
	Wy		0.287	0.317	0.347		
NTSC Ratio	NTSC	CIE1931	66.6	71.6	-	%	
Color Temperature	CT	-	-	-	2	%	
Luminance	Yw			1000		cd/m ²	
Flicker	amount	-	-	-	15	%	
Gamma		-	1.9	2.2	2.5	-	

**Note :**

1. Viewing angle is the angle at which the contrast ratio is greater than 10. The viewing angles are determined for the horizontal or 3, 9 o'clock direction and the vertical or 6, 12 o'clock direction with respect to the optical axis which is normal to the LCD surface (see FIGURE 4).
2. Contrast measurements shall be made at viewing angle of $\Theta = 0$ and at the center of the LCD surface. Luminance shall be measured with all pixels in the view field set first to white, then to the dark (black) state. (see FIGURE 1) Luminance Contrast Ratio (CR) is defined mathematically.

$$CR = \frac{\text{Luminance when displaying a white raster}}{\text{Luminance when displaying a black raster}}$$

3. Transmittance is the Value with Polarizer
4. The color chromaticity coordinates specified in Table 5 shall be calculated from the spectral data measured with all pixels first in red, green, blue and white. Measurements shall be made at the center of the panel.
5. The electro-optical response time measurements shall be made as FIGURE 3 by switching the "data" input signal ON and OFF. The times needed for the luminance to change from 10% to 90% is T_r , and 90% to 10% is T_d .



6.0 Mechanical Characteristics

Mechanical Drawing

Drawing Attachment: Front

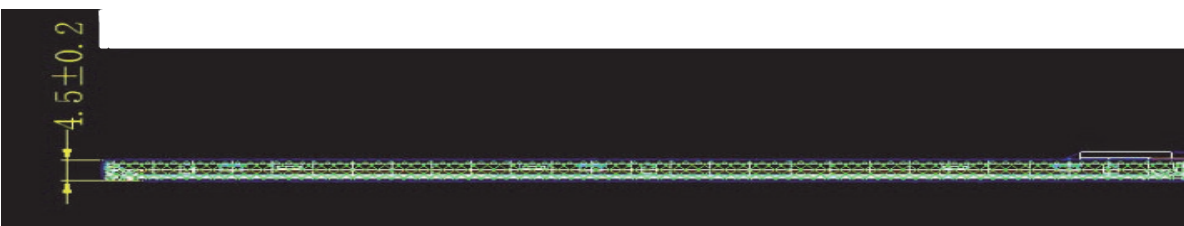
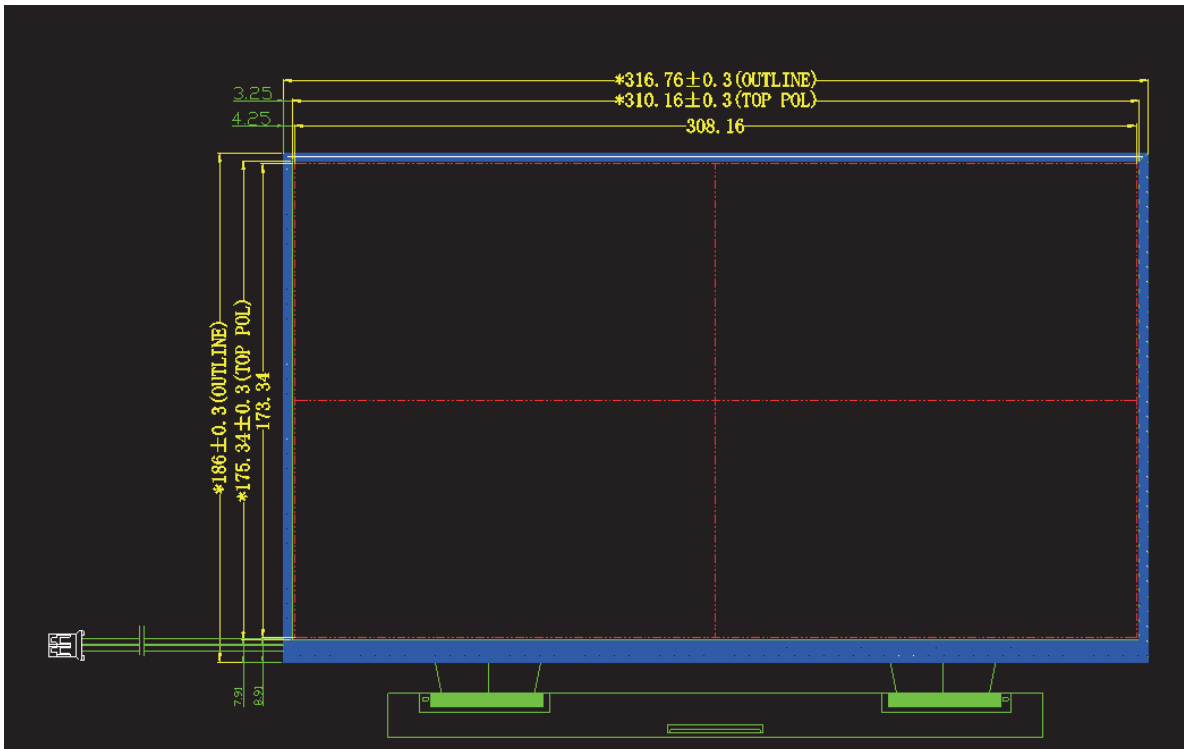



6.0 Mechanical Characteristics

Mechanical Drawing

Drawing Attachment: Back

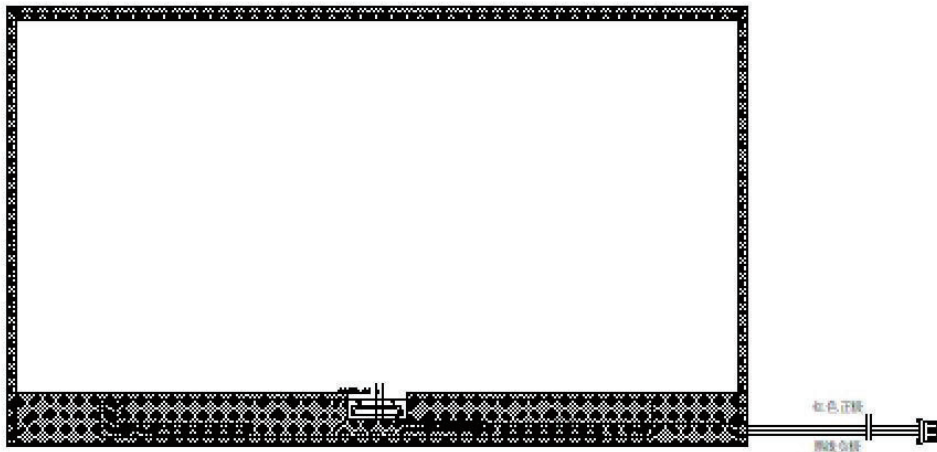

引线 (正接)

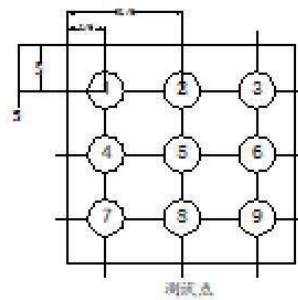
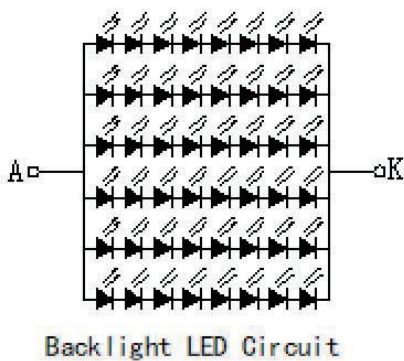



7.0 APPENDIX

Figure 1. Optical Test Equipment Setup

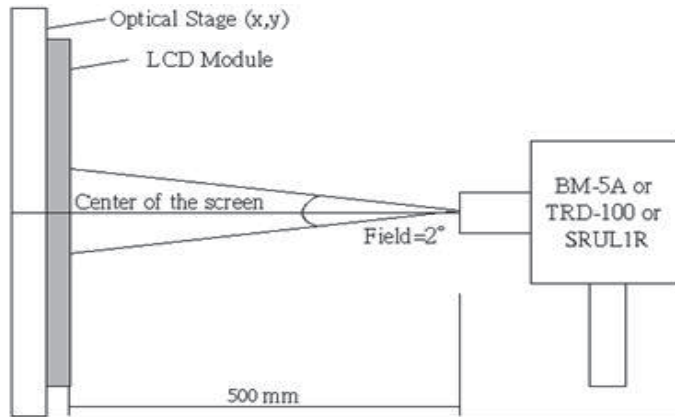

Figure 2. Response Time Testing

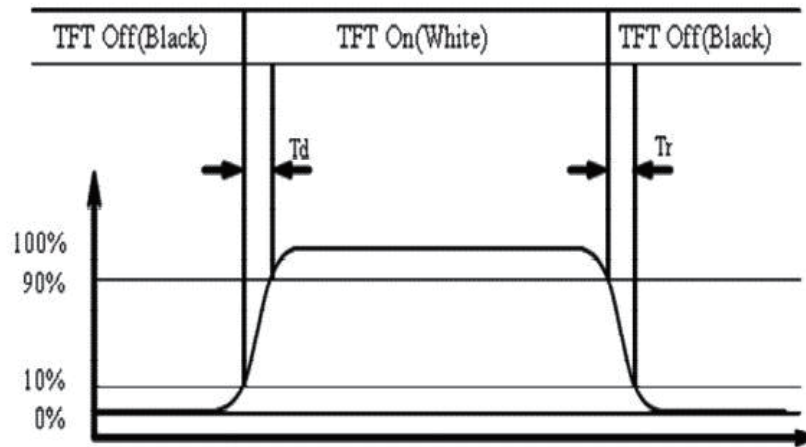

Figure 3. The Definition of V_{th} & V_{sat}

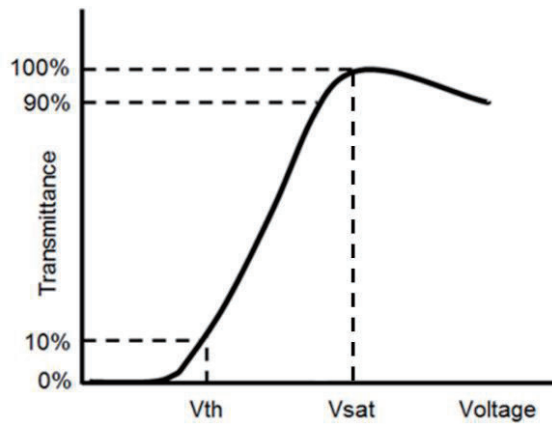



Figure 4. Viewing Angle Range is defined as follows;

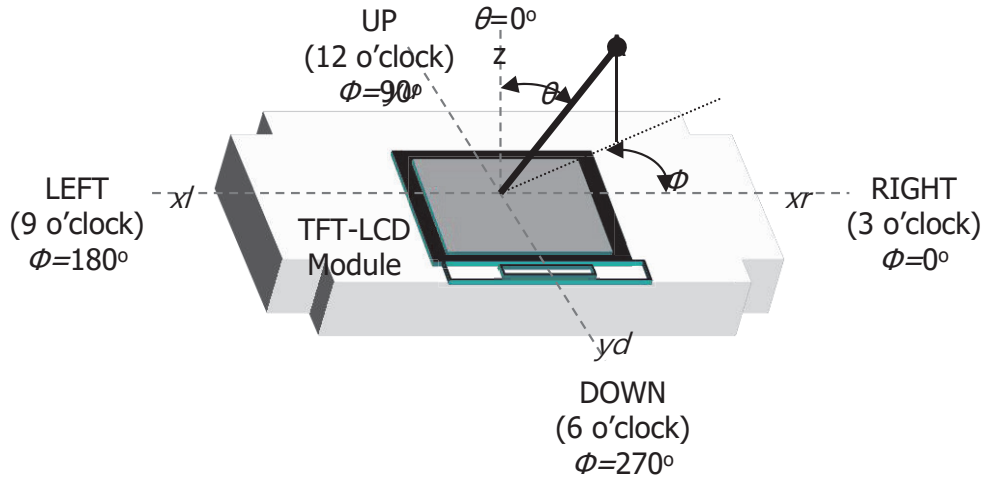

Figure 5. Pol General Spec

Item.	Front Polarizer	Rear Polarizer	Remark
Attaching (Adhesive Down)	<p>上偏光片 显示区 Absorption. Axis OA Direction 0.2mm 0.2mm 0.2mm 0.2mm</p> <p>CF玻璃面向上 偏光片保护膜面向上</p>	<p>下偏光片 显示区 Absorption. Axis OA Direction 0.2mm 0.2mm 0.2mm 0.2mm</p> <p>TFT玻璃面向上 偏光片保护膜面向上</p>	
Absorption. Axis	90° ± 0.5°	0° ± 0.5°	E-Mode
OA	0°	0°	
距AA边距	1.8/1.8/1.8/1.8	1.8/1.8/1.8/1.8	U/D/L/R
距离边框距离	0.2/0.2/0.2/0.2	0.2/0.2/0.2/0.2	U/D/L/R
Surface Treatment	AG25	Clear	



8.0 RELIABILITY TEST

The Reliability test items and its conditions are shown in below.

<Table 8. Reliability test>

No	Test Items	Conditions
1	High temperature storage test	Ta = 80 °C, 240 hrs
2	Low temperature storage test	Ta = -30°C, 240hrs
3	High temperature & high humidity operation test	Ta = 60 °C, 90%RH, 240hrs
4	High temperature operation test	Ta = 70 °C, 240 hrs
5	Low temperature operation test	Ta = -20 °C, 240hrs
6	Thermal shock test	Ta = -30 °C ↔ 80 °C (30min), 100cycle



9.0 Handling & Cautions

9.1 Mounting Method

- The panel of the LCD consists of two thin glasses with polarizers which easily get damaged. So extreme care should be taken when handling the LCD.
- Excessive stress or pressure on the glass of the LCD should be avoided. Care must be taken to insure that no torsional or compressive forces are applied to the LCD unit when it is mounted.
- If the customer's set presses the main parts of the LCD, the LCD may show the abnormal display. But this phenomenon does not mean the malfunction of the LCD and should be pressed by the way of mutual agreement.
- To determine the optimum mounting angle, refer to the viewing angle range in the specification for each model.
- Mount a LCD module with the specified mounting parts.
- Use fingerstalls of soft gloves in order to keep clean display quality, when persons handle the LCD for incoming inspection or assembly.
- This product is not authorized for use in life supporting systems, aircraft navigation control systems, military systems and any other application where performance failure could be life-threatening or otherwise catastrophic.



9.2 Caution of LCD Handling and Cleaning

- Since the LCD is made of glass, do not apply strong mechanical impact or static load onto it. Handling with care since shock, vibration, and careless handling may seriously affect the product. If it falls from a high place or receives a strong shock, the glass may be broken.
- The polarizers on the surface of panel are made from organic substances. Be very careful for chemicals not to touch the polarizers or it leads the polarizers to be deteriorated.
- If the use of a chemical is unavoidable, use soft cloth with solvent (recommended below) to clean the LCD's surface with wipe lightly.
-IPA(Isopropyl Alcohol), Ethyl Alcohol, Trichlorotrifluoroethane
- Do not wipe the LCD's surface with dry or hard materials that will damage the polarizers and others. Do not use the following solvent.
-Water, Ketone, Aromatics
- It is recommended that the LCD be handled with soft gloves during assembly, etc. The polarizers on the LCD's surface are vulnerable to scratch and thus to be damaged by sharp particles.
- Do not drop water or any chemicals onto the LCD's surface.
- A protective film is supplied on the LCD and should be left in place until the LCD is required for operation.
- The ITO pad area needs special careful caution because it could be easily corroded. Do not contact the ITO pad area with HCFC, Soldering flux, Chlorine, Sulfur, saliva or fingerprint. To prevent the ITO corrosion, customers are recommended that the ITO area would be covered by UV or silicon.
- Please use suction cup to grab the Q-Panel. Please use suction ball to grab the Cell. It is forbidden to touch the ITO pad area and Active Area.
- Repeatedly bonding will result in film peeling.
- The special tray should be used to avoid Q-panel bending while the placement, flipping, etc.
- When the LCD needs to be returned, please use special tray.
- When disposing LCD, obey the local environmental regulations.
- The ion wind blowing is the unique way to clean ITO pad area. No wipe.
- The LCD should be no falling and violent shocking during transportation, and also should avoid excessive press, water, damp and sunshine.



9.3 Caution Against Static Charge

- The LCD modules use C-MOS LSI drivers, so customers are recommended that any unused input terminal would be connected to Vdd or Vss, do not input any signals before power is turn on, and ground you body, work/assembly area, assembly equipments to protect against static electricity.
- Remove the protective film slowly, keeping the removing direction approximate 30-degree not vertical from panel surface, If possible, under ESD control device like ion blower, and the humidity of working room should be kept over 50%RH to reduce the risk of static charge.
- Avoid the use work clothing made of synthetic fibers. We recommend cotton clothing or other conductivity-treated fibers.
- In handling the LCD, wear non-charged material gloves. And the conducting wrist to the earth and the conducting shoes to the earth are necessary.
- To reduce the amount of static electricity generated, do not conduct assembly and other work under dry conditions.

9.4 Caution For operation

- It is indispensable to drive the LCD within the specified voltage limit since the higher Voltage than the limit causes the shorter LCD's life. An electro-chemical reaction due to DC causes undesirable deterioration of the LCD so that the use of DC drive should avoid.
- Do not connect or disconnect the LCD to or from the system when power is on.
- Never use the LCD under abnormal conditions of high temperature and high humidity.
- When expose to drastic fluctuation of temperature (hot to cold or cold to hot) ,the LCD may be affected; Specifically, drastic temperature fluctuation from cold to hot ,produces dew on the LCD's surface which may affect the operation of the polarizer and the LCD.
- Response time will be extremely delayed at lower temperature than the operating temperature range and on the other hand at higher temperature LCD may turn black at temperature above its operational range. However those phenomena do not mean malfunction or out of order with the LCD. The LCD will revert to normal operation once the temperature returns to the recommended temperature range for normal operation.
- Do not display the fixed pattern for a long time because it may develop image sticking due to the LCD structure. If the screen is displayed with fixed pattern, use a screen saver.
- The ET standard timing is required. Abnormal power-down will cause jitter.



10.0 Packaging

- Modules use LCD element, and must be treated as such.
 - Avoid intense shock and falls from a height.
 - To prevent modules from degradation, do not operate or store them exposed directly to sunshine or high temperature/humidity for long periods.

9.6 Storage

- A slight dew depositing on terminals is a cause for electro-chemical reaction resulting in terminal open circuit. Relative humidity of the environment should therefore be kept below 60%RH.
- Original protective film should be used on LCD's surface (polarizer). Adhesive type protective film should be avoided, because it may change color and/or properties of the polarizers.
- Do not store the LCD near organic solvents or corrosive gasses.
- Keep the LCD safe from vibration, shock and pressure.
- Black or white air-bubbles may be produced if the LCD is stored for long time in the lower temperature or mechanical shocks are applied onto the LCD.
- In the case of storing for a long period of time for the purpose or replacement use, the following ways are recommended.
 - Store in a polyethylene bag with sealed so as not to enter fresh air outside in it.
 - Store in a dark place where neither exposure to direct sunlight nor light is.
 - Keep temperature in the specified storage temperature range($25\pm 10^{\circ}\text{C}$).
 - Store with no touch on polarizer surface by the anything else. If possible, store the LCD in the packaging situation LCD when it was delivered.
 - The LCD should be stored in the room without acid, alkali and harmful gas.

9.7 Safety

- For the crash damaged or unnecessary LCD, it is recommended to wash off liquid crystal by either of solvents such as acetone and ethanol and should be burned up later.
- In the case the LCD is broken, watch out whether liquid crystal leaks out or not. If your hands touch the liquid crystal, wash your hands cleanly with water and soap as soon as possible.
- If you should swallow the liquid crystal, first, wash your mouth thoroughly with water, then drink a lot of water and induce vomiting, and then, consult a physician.
- If the liquid crystal should get in your eyes, flush your eyes with running water for at least fifteen minutes.
- If the liquid crystal touches your skin or clothes, remove it and wash the affected part of your skin or clothes with soap and running water.



10.1 LABEL

(1) High voltage caution label

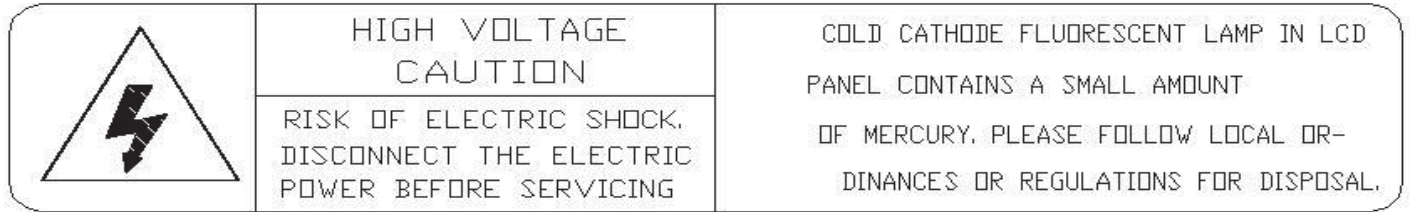

(2) Box label

Label Size: 110 mm (L) 56 mm (W)

Contents

Model: **YX140FHM-N10**

Q`ty: Cell Q`ty in one box

Serial No.: Box Serial No. See next figure for detail description.

Date: Packing Date

Internal use of Product

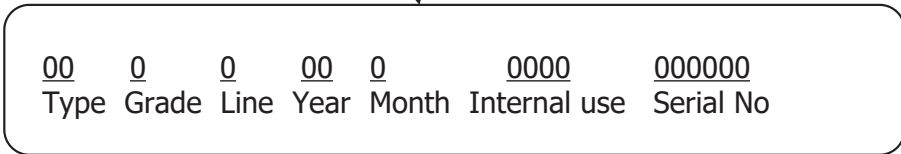
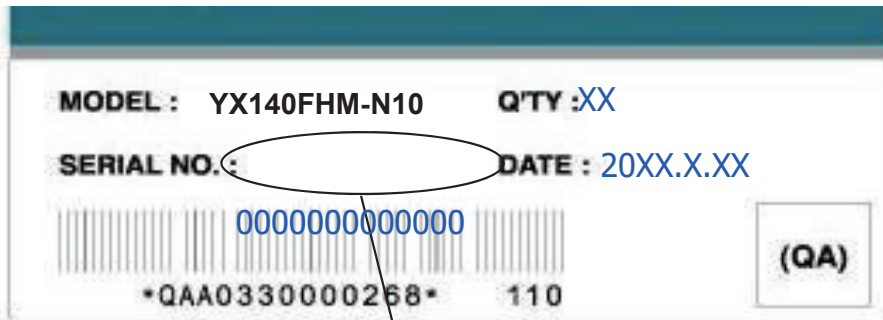

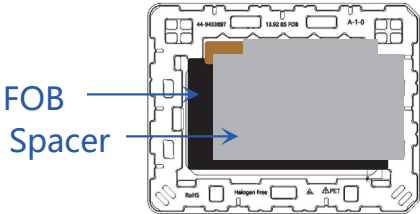

10.2 PACKING INFORMATION

<p>将FOB平放入Tray, CF朝上放置, 产品上放置1pcs Spacer</p> <p>1 FOB/1 Spacer/Tray</p>	<p>将30pcs Tray直叠堆叠码放, 不可旋转, 顶部放置1pcs 空Tray, 并放入Shielding Bag中, 抽真空封口 (真空要求详见 Appendix)</p> <p>31 Tray/Box 1 Shielding Bag/Box</p>	<p>将1包Tray平放入Box上下放置EPE Cushion</p> <p>2 EPE Cushion/Box 30 FOB/Box</p>
 <p style="text-align: center;">Step 1</p>	 <p style="text-align: center;">Step 2</p>	 <p style="text-align: center;">Step 3</p>
<p>采用“H”形封箱方式, 对Box进行封箱。</p>	<p>每个Pallet上放3层Box, 每层按照“目目”字形码放6箱, 长、宽、高方向安放护角, 长、宽边捆绑2道打包带, Pallet外进行至少3层缠膜</p> <p>18 Box/Pallet, 540 FOB/Pallet</p>	<p>厢车装载方式: 一横一竖双层码放 厢车装载量_12m: 21,600pcs (40托)</p>
 <p style="text-align: center;">Step 4</p>	 <p style="text-align: center;">Step 5</p>	 <p style="text-align: center;">Step 6</p>